

High Security Lock Replacement Instructions

MODEL 5123-HSwC

Hardware (included)

x1, large nut 

x1, lock housing 

Tools (not included)

One Phillips Screwdriver



One Wrench



- or -



- 1 Remove the screw with a screwdriver and pull the cam and large nut off the lock housing with a wrench or pliers. Now, slide the lock housing off the door.

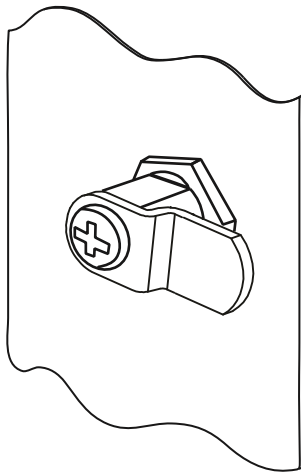

- 2 Insert the new lock housing into the door hole. Then, insert the lock bracket onto the lock housing from the back of the door and secure using the large nut.

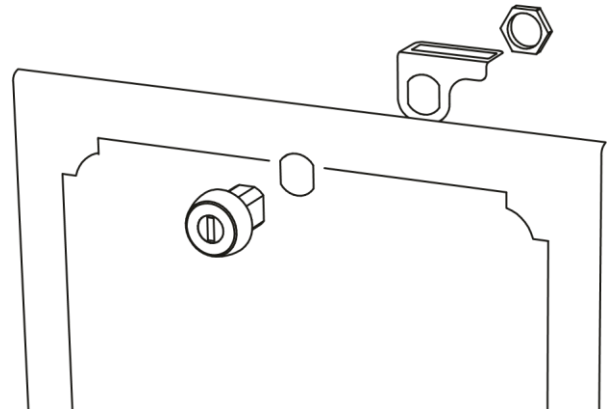

- 3 Insert the key and turn the lock into the unlocked (horizontal) position.

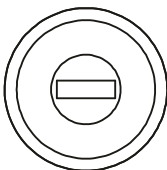

- 4 Attach the cam to the back of the lock housing in the orientation shown below and secure it with the washer and screw.

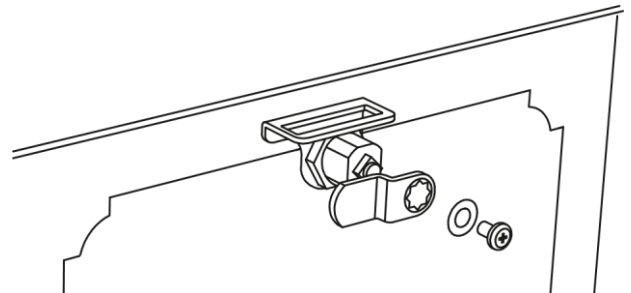



Questions, Comments, Concerns? Need keys? Visit us at... Find us on social media! www.architecturalmailboxes.com

 www.architecturalmailboxes.com/keys

 support@architecturalmailboxes.com

Rev. E © 2020, Architectural Mailboxes, LLC

  
[@archmailboxes](#)